

6540 - VEN DE WEILE

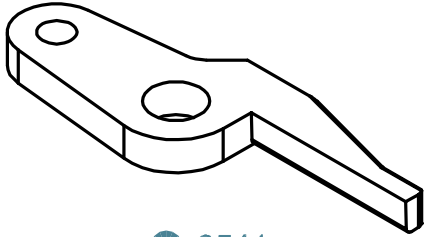

● 6541
12240277

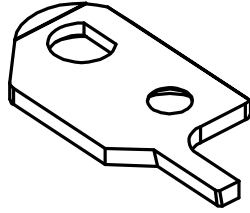

● 6542
12240445

6540-00
ASSEMBLY

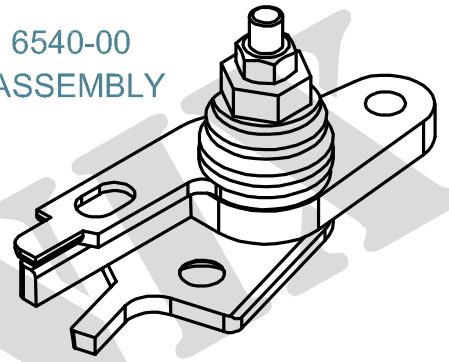

6550 - (SELVEDGE)

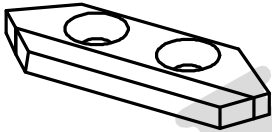

● 6551

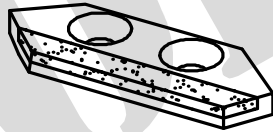

● 6553

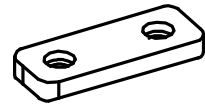

● 6552

7900 - (CARPET BLADE)

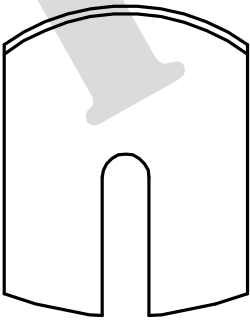

○ 7901

CODE	THK.
7901.35	0.35
7901.45	0.45
Steel Hardness : 60-62HRc.	

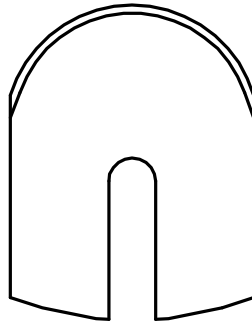

○ 7902

CODE	THK.
7902.35	0.35
7902.45	0.45
Steel Hardness : 60-62HRc.	

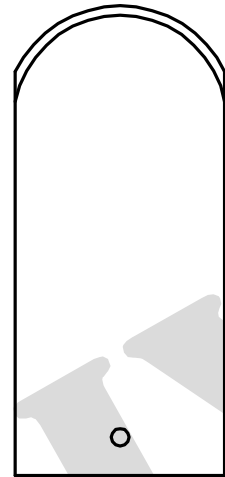

○ 7903

CODE :	THK.
7903.30	0.30
7903.45	0.45
Steel Hardness : 60-62HRc.	

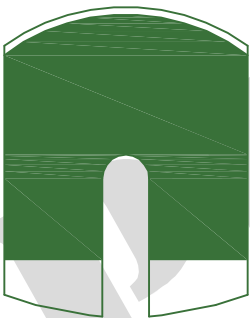

○ 7901P
Teflon Coated

CODE	THK.
7901.35P	0.35
7901.45P	0.45
Steel Hardness : 60-62HRc.	

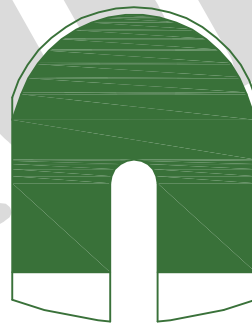

○ 7902P
Teflon Coated

CODE	THK.
7902.35P	0.35
7902.45P	0.45
Steel Hardness : 60-62HRc.	



○ 7903P
Teflon Coated

CODE	THK.
7903.30P	0.30
7903.45P	0.45
Steel Hardness : 60-62HRc.	

MATERIAL CODE : ● SOLID CARBIDE , ○ HSS , ● BRAZED CARBIDE , ◎ TIN COATED